

LESSO

Ahlinya Pipa Plastik

PVC Conduit and Fittings

SNI ISO 9001

SNI ISO 14001

SNI ISO 45001



PT. LESSO TECHNOLOGY INDONESIA

China Lesso Group (Stock Code: 2128.HK)

Alamat : Kawasan Industri JIPS Blok D, Jl. Semarang-Demak Km 14.7, Batu, Karangtengah, Kabupaten Demak
Jawa Tengah 59561, Indonesia

Telp: 08112588883

E-Mail: idn.consumer@lesso.com

Website: <https://lessoindonesia.co.id>

Pipa PVC Conduit

SAP No. (plain end/2.9M)	Size (mm)	Wall Thickness	Pack Qty	PRICE /PCS
8030050068	20	1.50	25	Rp 16,000.00
8030050080	25	1.65	20	Rp 23,000.00
8030050090	32	1.90	10	Rp 35,000.00



Coupling

SAP Number	Size (mm)	PCS /CTN	PRICE /PCS
8030020288	20	500	Rp 1,050.00
8030020289	25	300	Rp 1,700.00
8030020290	32	150	Rp 3,000.00



Male Adapter (for corrugated conduit)

SAP Number	Size (mm)	PCS /CTN	PRICE /PCS
8030020351	20	350	Rp 2,000.00
8030020352	25	200	Rp 3,200.00
8030020353	32	140	Rp 4,700.00



Male Adapter (for corrugated conduit) II

SAP Number	Size (mm)	PCS /CTN	PRICE /PCS
8030021225	20	350	Rp 1,800.00



Change Union (for corrugated conduit)

SAP Number	Size (mm)	PCS /CTN	PRICE /PCS
8030020790	20	350	Rp 1,800.00



Flexible Coupling

SAP Number	Size (mm)	PCS /CTN	PRICE /PCS
8030020141	20	500	Rp 1,200.00
8030020142	25	320	Rp 1,700.00
8030020143	32	200	Rp 2,900.00

Size: 16, 20



Size: ≥25



Flexible Reducer

SAP Number	Size (mm)	PCS /CTN	PRICE /PCS
8030020399	25x20		Rp 1,700.00
8030020400	32x16		Rp 2,400.00
8030020401	32x20		Rp 2,600.00
8030020402	32x25		Rp 2,900.00

Size: 16, 20



Size: ≥25



Tee

SAP Number	Size (mm)	PCS /CTN	PRICE /PCS
8030020171	20	210	Rp 2,600.00
8030020172	25	130	Rp 3,800.00
8030020173	32	70	Rp 6,000.00



Reducer

SAP Number	Size (mm)	PCS /CTN	PRICE /PCS
8030020271	25x20	480	Rp 1,700.00
8030020272	32x20	264	Rp 2,700.00
8030020273	32x25	264	Rp 3,000.00



45° Elbow

SAP Number	Size (mm)	PCS /CTN	PRICE /PCS
8030021230	20		Rp 1,500.00
8030021231	25		Rp 2,600.00
8030021212	32		Rp 4,400.00



90° Elbow

SAP Number	Size (mm)	PCS /CTN	PRICE /PCS
8030020207	20	350	Rp 1,500.00
8030020208	25	160	Rp 2,600.00
8030020209	32	90	Rp 4,200.00



90° Long Sweep Bend

SAP Number	Size (mm)	PCS /CTN	PRICE /PCS
8030020202	20	250	Rp 2,000.00
8030020203	25	130	Rp 3,200.00
8030020204	32	60	Rp 5,700.00



Elbow with Cover

SAP Number	Size (mm)	PCS /CTN	Price/PCS
8030020221	20	200	Rp 2,600.00
8030020222	25	125	Rp 3,300.00
8030020223	32	60	Rp 7,100.00



Tee with Cover

SAP Number	Size (mm)	PCS /CTN	Price/PCS
8030020185	20	80	Rp 5,400.00
8030020186	25	60	Rp 8,100.00
8030020187	32	30	Rp 13,800.00



1 Way Terminal Box (with cover)

SAP Number	Size (mm)	H	PCS /CTN	Price/PCS
8030020232	65x40/1/20	40	60	Rp 7,700.00
8030020233	65x40/1/25	40	60	Rp 8,300.00



2 Way Through Box (with cover)

SAP Number	Size (mm)	H	PCS /CTN	Price/PCS
8030020257	65x40/2L/20	40	50	Rp 8,100.00
8030020258	65x40/2L/25	40	50	Rp 8,900.00



2 Way Angle Box (with cover)

SAP Number	Size (mm)	H	PCS /CTN	Price/PCS
8030020240	65x40/3/20	40	50	Rp 8,300.00
8030020241	65x40/2L/25	40	50	Rp 9,000.00



3 Way Tee Box (with cover)

SAP Number	Size (mm)	H	PCS /CTN	Price/PCS
8030020192	65x40/3/20	40	50	Rp 8,600.00
8030020193	65x40/3/25	40	40	Rp 9,600.00



1 Way Deep Terminal Box (Concealed Installation)

SAP Number	Size (mm)	H	PCS /CTN	Price/PCS
8030020113	65x65/1/20	65	30	Rp 9,000.00
8030020114	65x65/1/25	65	30	Rp 9,300.00
8030020378	65x70/1/20	70	30	Rp 10,700.00
8030020368	65x70/1/25	70	30	Rp 11,000.00



2 Way Deep Terminal Box (Concealed Installation)

SAP Number	Size (mm)	H	PCS /CTN	Price/PCS
8030020268	65x65/2/20	65	30	Rp 9,600.00
8030020269	65x65/2/25	65	30	Rp 10,200.00
8030020380	65x70/2/20	70	30	Rp 11,300.00
8030020381	65x70/2/25	70	30	Rp 11,900.00



2 Way Deep Angle Box (Concealed Installation)

SAP Number	Size (mm)	H	PCS /CTN	Price/PCS
8030020116	65x65/2L/20	65	30	Rp 9,600.00
8030020117	65x65/2L/25	65	25	Rp 10,200.00
8030020379	65x70/2L/20	70	30	Rp 10,800.00
8030020367	65x70/2L/25	70	25	Rp 14,100.00



3 Way Deep Tee Box (concealed installation)

SAP Number	Size (mm)	H	PCS /CTN	Price/PCS
8030020168	65x65/3/20	65	30	Rp 11,000.00
8030020169	65x65/3/25	65	25	Rp 11,100.00
8030020382	65x70/3/20	70	30	Rp 11,900.00
8030020383	65x70/3/25	70	25	Rp 15,000.00



4 Way Deep Cross Box (concealed installation)

SAP Number	Size (mm)	H	PCS /CTN	Price/PCS
8030020119	65x65/4/20	65	25	Rp 11,000.00
8030020120	65x65/4/25	65	25	Rp 12,000.00
8030020122	65x70/4/20	70	25	Rp 12,300.00
8030020123	65x70/4/25	70	25	Rp 16,500.00



Gang Box (with active foot, concealed installation)

SAP Number	Size (mm)	H	PCS /CTN	Price/PCS
8030020044	77x77/20	38	40	Rp 7,500.00
8030020046	77x77/20 25	38	40	Rp 7,500.00
8030020045	77x77/20	48	35	Rp 8,300.00
8030020047	77x77/20 25	48	35	Rp 8,300.00
8030020062	77x77/20	56	30	Rp 9,200.00
8030020064	77x77/20 25	56	30	Rp 9,200.00
8030020063	77x77/20	70	30	Rp 10,500.00
8030020065	77x77/20 25	70	30	Rp 10,500.00
8030020052	64x77/16x2 20 2	38	22	Rp 13,200.00
8030020054	64x77/20x2 20 2	50	18	Rp 16,500.00



Gang Box (with active foot, concealed installation)

SAP Number	Size (mm)	H	PCS /CTN	Price/PCS
8030020055	141x80/20	50	22	Rp 12,000.00
8030020053	155x75/20x2 25x	50	12	Rp 26,100.00



Deeper Assembling Gang Box (through reinforcement type, concealed installation)

SAP Number	Size (mm)	H	PCS /CTN	Price/PCS
8030020066	81x81/20	50	35	Rp 8,600.00
8030021130	81x81/25	50		Rp 8,600.00



Insert Reinforce Lengthened Assembling Gang Box (through reinforcement type, concealed installation)

SAP Number	Size (mm)	H	PCS /CTN	Price/PCS
8030020917	77x77/20	60	32	Rp 12,200.00
8030020864	77x77/20	70	27	Rp 13,200.00
8030020865	77x77/20 25	70	27	Rp 13,200.00
8030020866	77x77/25	70	27	



Gang Box (surface installation)

SAP Number	Size (mm)	H	PCS /CTN	Price/PCS
8030020071	86x86/20 25	40	40	Rp 7,800.00
8030021168	86x86/20	40	36	Rp 9,200.00
8030020070	86x86/20	54	30	Rp 9,500.00
8030020072	86x86/20 25	54	30	Rp 9,500.00
8030020068	86x86/20	46	36	Rp 8,400.00
8030020069	86x86/20 25	46	36	Rp 9,900.00



Transfer Frame

SAP Number	Size (mm)	H	PCS /CTN	Price/PCS
8030020388	77x77	22	91	Rp 5,300.00



Gang Box (through reinforcement type, concealed installation)

SAP Number	Size (mm)	H	PCS /CTN	Price/PCS
8030020056	77x77/20	50	37	Rp 8,100.00
8030020057	77x77/20	60	32	Rp 10,700.00
8030020058	77x77/20	70		Rp 10,100.00
8030020562	77x77/20 25	50	37	Rp 8,100.00
8030020059	77x77/20 25	60	32	Rp 9,000.00
8030020060	77x77/20 25	70		Rp 10,100.00
8030020618	77x77/20	70		Rp 12,300.00
8030020619	77x77/20 25	70		Rp 12,300.00
8030020918	77x77/20	60		Rp 11,400.00
8030020919	77x77/20 25	60		



Gang Box (typy III, concealed installation)



SAP Number	Size (mm)	H	PCS /CTN	Price/PCS
8030020617	77x77/20	50	50	Rp 7.700,00

Gang Box (through reinforcement type, concealed installation)



SAP Number	Size (mm)	H	PCS /CTN	Price/PCS
8030020620	141x80/20	50	22	Rp 11.400,00
8030020663	164x77/16 20 25	38	22	Rp 15.300,00
8030020664	164x77/20 25	50	18	Rp 18.200,00

Rib-piercing Deeper Assembling Gang Box (through reinforcement type, concealed installation)



SAP Number	Size (mm)	H	PCS /CTN	Price/PCS
8030021235	77x77/20	70	Rp	13.800,00
8030021236	77x77/20 25	70	Rp	13.800,00

Gang Box (through reinforcement type, with 8 active feet, concealed installation)



SAP Number	Size (mm)	H	PCS /CTN	Price/PCS
8030020661	77x77/20	70	38	Rp 10.200,00
8030020763	77x77/20	60	Rp	9.000,00
8030020764	77x77/25	60	Rp	9.300,00

Rib-piercing Gang Box (through reinforcement type, with 8 active feet, concealed installation)



SAP Number	Size (mm)	H	PCS /CTN	Price/PCS
8030020041	77x77/20	50	45	Rp 6.800,00
8030020042	77x77/20	60	40	Rp 7.400,00
8030020043	77x77/20	70	38	Rp 8.300,00
8030020557	77x77/20 25	70	Rp	8.300,00
8030020851	77x77/25	70	Rp	9.800,00

Gang Box Cover



Size:75x75-86x86



Size:100x75-172x86

SAP Number	Size (mm)	PCS /CTN	Price/PCS
8030020387	75x75	340	Rp 3.000,00
8030020920	77x77	250	Rp 2.600,00
8030020369	86x86	230	Rp 2.900,00
8030020384	100x75	Rp	3.800,00
8030020385	147x86	160	Rp 8.400,00
8030020386	164x77	160	Rp 6.300,00
8030020733	172x86	Rp	7.100,00

Box Cover (with 8 active feet)



SAP Number	Size (mm)	PCS /CTN	Price/PCS
8030021196	77x77	Rp	3.600,00

Box Cover



SAP Number	Size (mm)	PCS /CTN	Price/PCS
8030020255	65	600	Rp 2.100,00

Assembling Clamp



SAP Number	Size (mm)	PCS /CTN	Price/PCS
8030020421	20	1000	Rp 800,00
8030020422	25	1000	Rp 1.100,00
8030020423	32	500	Rp 1.400,00

Clamp



(Ø16)



(Ø20-Ø50)

SAP Number	Size (mm)	PCS /CTN	Price/PCS
8030020127	20	1000	Rp 600,00
8030020128	25	900	Rp 900,00
8030020129	32	500	Rp 1.200,00

U Style Clamp



SAP Number	Size (mm)	PCS /CTN	Price/PCS
8030021111	20	900	Rp 600,00
8030021112	25	Rp	600,00

8030020594	20	1500	Rp 500,00
8030020595	25	1000	Rp 600,00
8030020596	32	500	Rp 750,00

Double U Clamp



SAP Number	Size (mm)	PCS /CTN	Price/PCS
8030020737	20	Rp	800,00
8030020750	25	Rp	1.200,00
8030020751	32		

Plug



SAP Number	Size (mm)	PCS /CTN	Price/PCS
8030020159	20	3000	Rp 200,00
8030020160	25	2000	Rp 200,00

Tools

Plug



SAP Number	Size (mm)	PCS /CTN	Price/PCS
8030020361	20	20	Rp 39.800,00
8030020364	25	10	Rp 52.500,00
8030020376	32	8	Rp 79.500,00

LESSO

Ahlinya Pipa Plastik

PP-R Water Pipe and Fittings (Green)

SNI ISO 9001

SNI ISO 14001

SNI ISO 45001

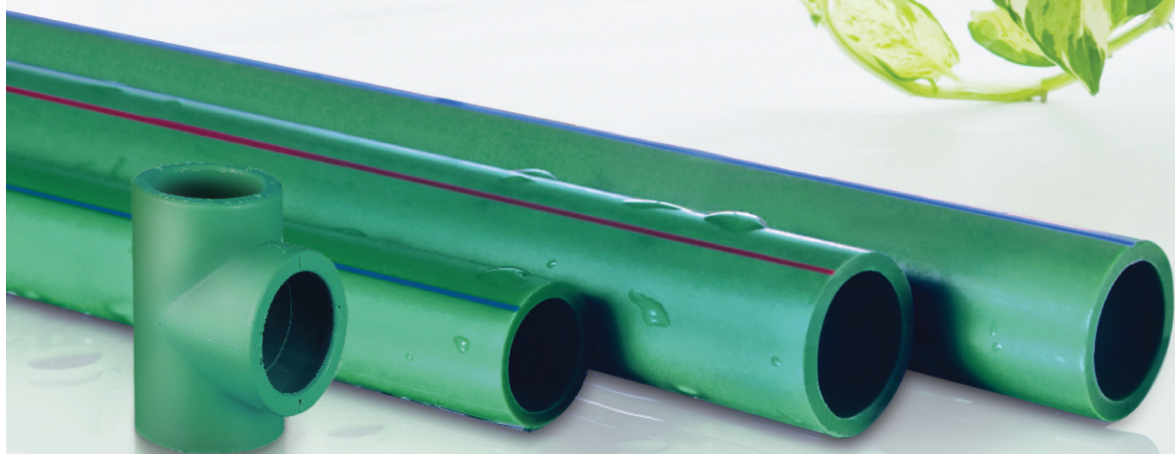



PP-R Straight Pipe

Product Overview

Material

Random Polypropylene

Ukuran

16mm (5/8 inch) – 160mm (6 inch)

Pressure Rating

1.25 Mpa, 1,6Mpa, 2.0Mpa, 2.5Mpa

Standard

ISO 15874-2 , EN ISO 15874-2, BS EN ISO 15874-2, BS 6920, DIN 8077/78, GB/T 18742-2

Warna

Hijau. Pipa untuk air panas ditandai dengan garis merah, pipa untuk air dingin ditandai dengan garis biru.

Application

1. Instalasi pipa air panas dan air dingin
2. Instalasi pendistribusian cairan kimia
3. Instalasi pada sistem pemanas ruangan dan lantai

Physical Properties

Properties

Specific Gravity, g/cm³ (20° C)

Tensile Strength, MPa

Modulus of Elasticity, N/mm² (20° C)

Thermal Conductivity, w/(mk) (20° C)

Coefficient of Linier Expansion, mm/(mk)

Longitudinal Reversion, % (135° C, 2h)

Typical Value

0.89 ~ 0.91

≥ 20

800

0.23 ~ 0.24

0.14 ~ 0.16

≤ 2

Hydraulic Pressure Test

20° C, 1h, Hoop Stress is 16MPa

No Failure

95° C, 1000h, Hoop Stress is 3.5MPa

No Failure

110° C, 8760h, Hoop Stress is 1.90MPa

No Failure

Benefits

1. Ketahanan suhu tinggi

PP-R LESSO memiliki tingkat *sustained working pressure* lebih dari 70° celcius dan memiliki tingkat *transient temperature* lebih dari 95° celcius.

2. Ketahanan panas yang baik

Konduktif *low thermal* yang hanya 1/1500 dari kuningan dan 1/250 dari pipa tembaga.

3. Bebas dari racun

Bebas dari kandungan logam berat, sehingga tidak akan terkontaminasi kotoran dari bakteri.

4. Tingkat ketahanan *corrosion* yang baik

5. Kapasitas flow tinggi

Pipa PP-R LESSO memiliki struktur interior yang licin dan tingkat gesekan yang rendah sehingga *flow* yang dihasilkan tinggi.

6. Struktur pipa kuat

Bebas dari kandungan logam berat, sehingga tidak akan terkontaminasi kotoran dari bakteri.

7. Ramah lingkungan

8. Ketahanan Pipa 50 tahun

Pipa dapat digunakan lebih dari 50 tahun dengan penggunaan yang tepat.

Note: The plastic fittings should be adopted threaded metal fittings with corrosion resistance when they are intended to connect with metal pipe and water transportation device.





Ahlinya Pipa Plastik

HARGA PIPA LESSO PP-R GREEN PANJANG 4 M/BATANG

DN		PN12.5		PN16		PN20	
MM	INCH	SAP NO.	Incl. PPN*	SAP NO.	Incl. PPN*	SAP NO.	Incl. PPN*
20	1/2"	8010060771	Rp. 44,000	8010061300	Rp. 49,000	8010060781	Rp. 55,200
25	3/4"	8010060772	Rp. 62,900	8010061301	Rp. 76,500	8010060782	Rp. 84,700
32	1	8010060773	Rp. 98,700	8010061302	Rp. 123,000	8010060783	Rp. 139,300
40	1-1/4"	8010060774	Rp. 161,800	8010061303	Rp. 191,100	8010060784	Rp. 214,700
50	1-1/2"	8010060775	Rp. 246,100	8010061304	Rp. 298,400	8010060785	Rp. 335,500
63	2"	8010060776	Rp. 392,600	8010061305	Rp. 469,200	8010060786	Rp. 531,500
75	2-1/2"	8010060777	Rp. 631,900	8010061306	Rp. 668,00	8010060787	Rp. 752,400
90	3"	8010060778	Rp. 786,400	8010061307	Rp. 957,500	8010060788	Rp. 1,081,400
110	4"	8010060779	Rp. 1,233,800	8010061298	Rp. 1,434,400	8010060789	Rp. 1,616,100
160	6"	8010060780	Rp. 3,330,000	8010061299	Rp. 4,828,600	8010061048	Rp. 5,507,400

Keterangan:

- *Harga sudah termasuk PPN 11%.
- Harga PP-R Water Pipe Fittings sudah termasuk PPN 11%.
- PN12.5: Aplikasi air panas@dingin tekanan kerja maksimal 12.5 Bar.
- PN16: Aplikasi air panas@dingin tekanan kerja maksimal 16 Bar.
- PN20: Aplikasi air panas@dingin tekanan kerja maksimal 20 Bar.

DN: Diameter Nominal



PP-R Water Pipe Fittings



Product Overview

Material

Random Polypropylene

Ukuran

16mm (5/8 inch) – 160mm (6 inch)

Pressure Rating

1.25 Mpa, 1,6Mpa, 2.0Mpa, 2.5Mpa

Standard

ISO 15874-2, EN ISO 15874-2, BS EN ISO 15874-2, BS 6920, DIN 8077/78, GB/T 18742-2

Warna

Hijau. Pipa untuk air panas ditandai dengan garis merah, pipa untuk air dingin ditandai dengan garis biru.

Joint

Sistem penyambungan pipa dan *fitting* menggunakan mesin *socket fusion*.

Benefits

1. Ketahanan suhu tinggi

PP-R LESSO memiliki tingkat *sustained working pressure* lebih dari 70° celcius dan memiliki tingkat *transient temperature* lebih dari 95° celcius.

2. Ketahanan panas yang baik

Konduktif *low thermal* yang hanya 1/1500 dari kuningan dan 1/250 dari pipa tembaga.

3. Bebas dari racun

Bebas dari kandungan logam berat, sehingga tidak akan terkontaminasi kotoran dari bakteri.

4. Tingkat ketahanan *corrosion* yang baik

5. Kapasitas flow tinggi

Pipa PP-R LESSO memiliki struktur interior yang licin dan tingkat gesekan yang rendah sehingga *flow* yang dihasilkan tinggi.

6. Struktur pipa kuat

Bebas dari kandungan logam berat, sehingga tidak akan terkontaminasi kotoran dari bakteri.

7. Ramah lingkungan

8. Ketahanan Pipa 50 tahun

Pipa dapat digunakan lebih dari 50 tahun dengan penggunaan yang tepat.

Coupling (Soc x Soc)

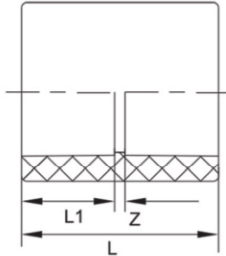

No. SAP	Size (mm)	Inch	Z	L1	L	Price (Rp)
8010071377	20	1/2"	1.5	16	33.5	4,500
8010071378	25	3/4"	1.5	18	37.5	5,500
8010071379	32	1"	2	20	42	8,000
8010071380	40	1-1/4"	1.5	22.5	46.5	15,500
8010071381	50	1-1/2"	2	25.5	53	26,000
8010071382	63	2"	2	29.5	61	42,000
8010071383	75	2-1/2"	2	31.5	65	68,000
8010071384	90	3"	3.5	36.5	76.5	138,000
8010071385	110	4"	5	42	89	189,000
8010071386	160	6"	9	58.5	126	579,500

Reducer (Soc x Soc)

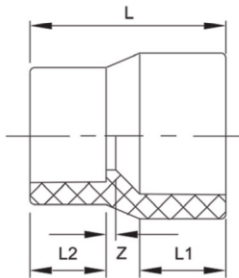

No. SAP	Size (mm)	Inch	Z	L1	L	Price (Rp)
8010071445	25x20	3/4"x1/2"	2	16	39.5	4,300
8010071446	32x20	1"x1/2"	2	16	42.5	6,300
8010071447	32x25	1"x3/4"	2	18	45	7,200
8010071448	40x20	1-1/4"x1/2"	2.5	16	46	12,500
8010071449	40x25	1-1/4"x3/4"	2	18	48.5	13,000
8010071450	40x32	1-1/4"x1"	3	20	50.5	14,500
8010071451	50x20	1-1/2"x1/2"	1.5	16	51.5	19,500
8010071452	50x25	1-1/2"x3/4"	2	18	52.5	22,000
8010071453	50x32	1-1/2"x1"	2.5	20	57	23,500
8010071454	50x40	1-1/2"x1-1/4"	1.6	22.5	57.5	28,500
8010071455	63x25	2"x3/4"	3	18	53	36,000
8010071456	63x32	2"x1"	2	20	56	37,000
8010071457	63x40	2"x1-1/4"	2	22.5	57.5	38,000
8010071458	63x50	2"x1-1/2"	2	22.5	60	39,000
8010072361	75x32	2-1/2"x1"	3	20	60.5	55,600
8010071459	75x40	2-1/2"x1-1/4"	3	22.5	63	56,000
8010071460	75x50	2-1/2"x1-1/2"	3	25.5	66	58,000
8010071461	75x63	2-1/2"x2"	3	29.5	68	61,000
8010071462	90x40	3"x1-1/4"	3	22.5	73	96,000
8010071463	90x50	3"x1-1/2"	2	25.5	73	97,000
8010071464	90x63	3"x2"	2.5	29.5	78	103,000
8010071465	90x75	3"x2-1/2"	2.5	31.5	88	110,500
8010071466	110x50	4"x1-1/2"	3	25.5	82.5	166,000
8010071467	110x63	4"x2"	4	29.5	85	160,000
8010071468	110x75	4"x2-1/2"	4	31.5	88	237,600
8010071469	110x90	4"x3"	5.5	37.5	94.5	180,000
8010071470	160x110	6"x4"	3	42	127	560,000

Double Female Thread Elbow with Seat (Soc x Fipt with Metal Insert)

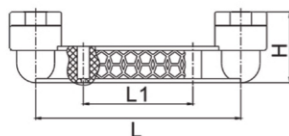
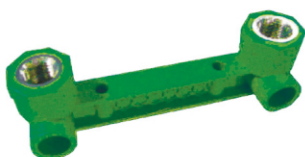

No. SAP	Size (mm)	Z	L1	H	Price (Rp)
8010072359	20x1/2"	80	150	51.5	125,000

Stub Flange (Soc x Flange)

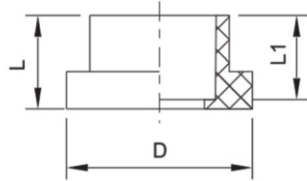
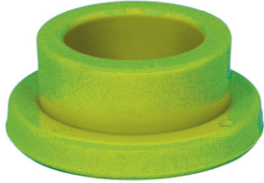

No. SAP	Size(mm)	Inch	D	L1	L	Price (Rp)
8010071331	40	1-1/4"	72	22.5	26	25,000
8010071332	50	1-1/2"	85	25.5	29	36,500
8010071333	63	2"	106	29.5	34.5	74,000
8010071341	75	2-1/2"	129	31.5	37	84,000
8010071334	90	3"	144	34.5	40	140,000
8010071335	110	4"	164	42	50	225,000
8010071336	160	6"	285	57.5	85	805,000

45° Elbow (Soc x Soc)

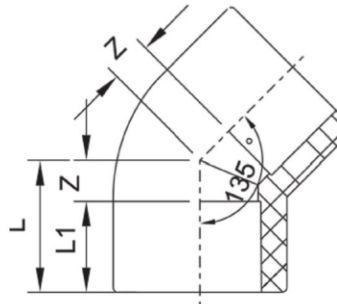

No. SAP	Size(mm)	Inch	Z	L1	L	Price (Rp)
8010071435	20	1/2"	6.3	16	22.3	4,500
8010071436	25	3/4"	7	18	25	6,500
8010071437	32	1"	10	20	30	12,300
8010071438	40	1-1/4"	10.5	22.5	33	23,000
8010071439	50	1-1/2"	12	25.5	37.5	52,800
8010071440	63	2"	14	29.5	43.5	60,000
8010071441	75	2-1/2"	16.5	31.5	48	114,000
8010071442	90	3"	21.5	37.5	59	255,000
8010071443	110	4"	25.5	42	67.5	310,000
8010071444	160	6"	49.5	58.5	108	1,140,000

90° Elbow (Soc x Soc)

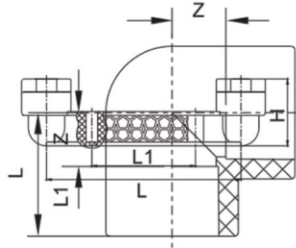

No. SAP	Size(mm)	Inch	Z	L1	L	Price (Rp)
8010071401	20	1/2"	11	16	27	4,700
8010071402	25	3/4"	13.5	18	31.5	7,500
8010071403	32	1"	17.5	20	37.5	15,000
8010071404	40	1-1/4"	21	22.5	43.5	25,500
8010071405	50	1-1/2"	26.5	25.5	52	46,500
8010071406	63	2"	32.5	29.5	62	84,000
8010071407	75	2-1/2"	37.5	31.5	69	130,000
8010071408	90	3"	44.5	37.5	82	234,500
8010071409	110	4"	55	42	97	444,500
8010071410	160	6"	92.5	58.5	151	1,380,000

Tee (Soc x Soc)

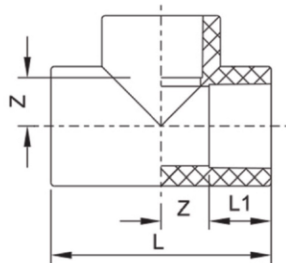

No. SAP	Size(mm)	Inch	Z	L1	L	Price (Rp)
8010071411	20	1/2"	10	16	54	5,800
8010071412	25	3/4"	14	18	64	9,400
8010071413	32	1"	17.8	20	75.5	18,000
8010071414	40	1-1/4"	21.5	22.5	88	31,000
8010071415	50	1-1/2"	26.5	25.5	104	57,500
8010071416	63	2"	32.5	29.5	124	102,500
8010071417	75	2-1/2"	37.8	31.5	138.5	160,000
8010071418	90	3"	45.5	37.5	166	280,000
8010071419	110	4"	55.5	42	195	510,000
8010071420	160	6"	91.5	58.5	300	1,790,000

Pipe Clamp

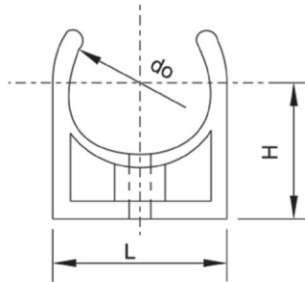

No. SAP	Size (mm)	Inch	L	do	H	Price (Rp)
8010071430	20	1/2"	27.5	19	22	2,300
8010071431	25	3/4"	32	24.6	24.5	2,600
8010071432	32	1"	39	31.5	28.5	3,600
8010071433	40	1-1/4"	47.5	38.5	32	4,100
8010071434	50	1-1/2"	57.5	48.5	37	4,800

Union (Soc x Soc)

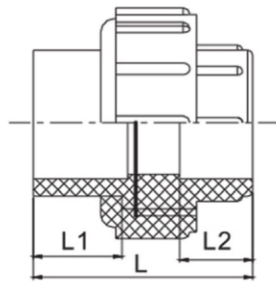

No. SAP	Size (mm)	Inch	L1	L2	L	Price (Rp)
8010071338	20	1/2"	16	16	45	16,000
8010071339	25	3/4"	18	17	48	19,800
8010071340	32	1"	20.5	18	58	33,000

Cap (Soc)

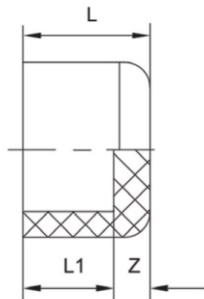

No. SAP	Size (mm)	Inch	Z	L1	L	Price (Rp)
8010071421	20	1/2"	4.5	16	20.5	2,800
8010071422	25	3/4"	4.5	17	22.5	4,000
8010071423	32	1"	6.5	20	26.5	6,000
8010071424	40	1-1/4"	8	22.5	30.5	12,500
8010071425	50	1-1/2"	9.5	25.5	35	25,500
8010071426	63	2"	12	29.5	41.5	43,500
8010071427	75	2-1/2"	13	31	44	80,000
8010071428	90	3"	15.5	35.5	51	96,000
8010071429	110	4"	18	42	60	250,800
8010071736	160	6"	48.5	58.5	107	693,000

Stop Valve (Soc x Soc)

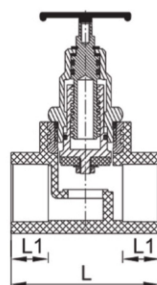

No. SAP	Size (mm)	Inch	L	L1	Price (Rp)
8010071345	20	1/2"	64	16	150,000
8010071346	25	3/4"	74	18	200,000
8010071347	32	1"	82	20.5	380,000
8010071348	40	1-1/4"	85	22	400,000
8010071349	50	1-1/2"	115	25	590,000
8010071350	63	2"	121	29	850,000

Cross

(Soc × Soc × Soc × Soc)

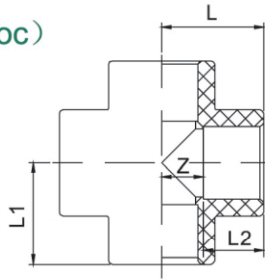

No. SAP	Size (mm)	Inch	Z	L1	L	L2	Price (Rp)
8010072477	20	1/2"	11	27	27	16	8,800
8010072478	25	3/4"	14.8	32.8	32.8	18	14,000
8010072479	32	1"	17.8	37.8	37.8	20	27,000

Ball Valve

(Spig × Spig)

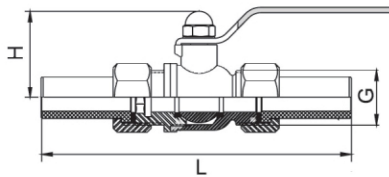

No. SAP	Size (mm)	Inch	L	G	H	Price (Rp)
8010072514	20	1/2"	142	3/4"	35	335,000
8010072515	25	3/4"	153	1"	37	590,000
8010072516	32	1"	172	1 1/4"	47.5	900,000

Ture Union Ball Valve

(Socket Type) II (Soc × Soc)

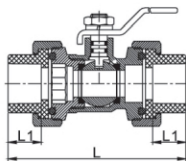

No. SAP	Size (mm)	Inch	L1	L	Price (Rp)
8010071342	20	1/2"	16	85.8	310,000
8010071343	25	3/4"	18	93.8	420,700
8010071344	32	1"	20	103.2	750,000

Female Thread Tee I (Soc x Soc x Fipt with Metal Insert)

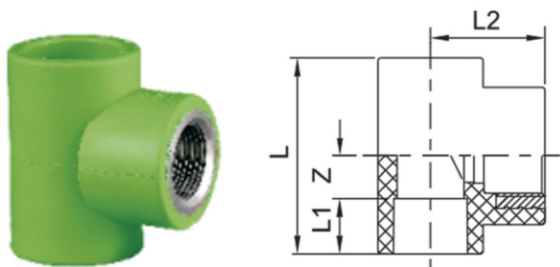

No. SAP	Size (mm)	Inch	Z	L2	L1	L	Price (Rp)
8010071471	20x1/2"	1/2"	11.5	38	16	55	55,000
8010072484	20x3/4"	1/2"x3/4"	13.5	38.5	16	59	78,000
8010071472	25x1/2"	3/4"x1/2"	12	41	18	60	51,000
8010071473	25x3/4"	3/4"	13.5	40.5	18	63	68,000
8010071474	32x1/2"	1"x1/2"	11.8	41.5	20	63.5	55,000
8010071475	32x3/4"	1"x3/4"	14.5	42	20	69	72,000

Female Thread Tee II (Soc x Soc x Fipt with Metal Insert)

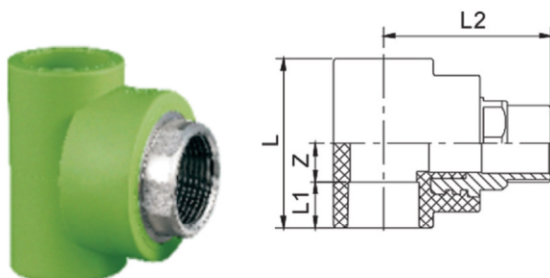

No. SAP	Size (mm)	Inch	Z	L2	L1	L	Price (Rp)
8010070525	20x1/2"	1/2"	13	44	16	58	110,800
8010071476	32x1"	1"	16.5	53.5	20	73	277,200
8010071289	40x1-1/4"	1-1/4"	28.5	65	22.5	102	594,000

Male Thread Tee I (Soc x Soc x Mipt with Metal Insert)

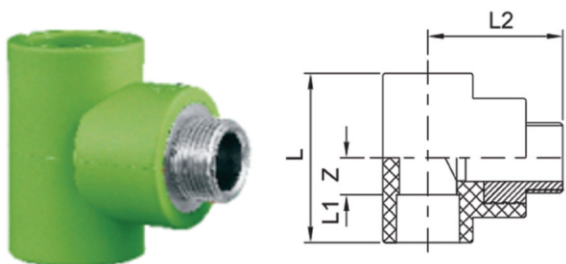

No. SAP	Size (mm)	Inch	Z	L2	L1	L	Price (Rp)
8010071477	20x1/2"	1/2"	11.5	49.5	16	55	91,800
8010071478	20x3/4"	1/2"x3/4"	13.5	50	16	59	112,000
8010071479	25x1/2"	3/4"x1/2"	12	52.5	18	60	101,200
8010071480	25x3/4"	3/4"	13.5	52.5	18	63	116,200
8010071481	32x1/2"	1"x1/2"	11.8	56	20	63.5	81,000
8010071482	32x3/4"	1"x3/4"	14.5	56	20	69	158,400

Male Thread Tee II (Soc x Soc x Mipt with Metal Insert)

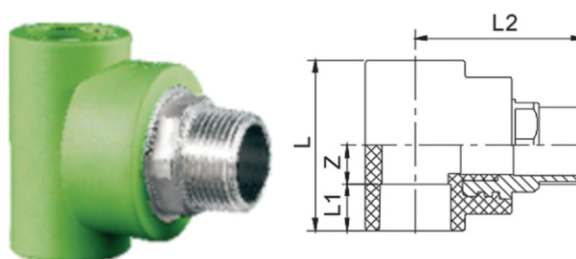

No. SAP	Size (mm)	Inch	Z	L2	L1	L	Price (Rp)
8010071483	32x1"	1"	16.5	72.5	20	73	277,200
8010071287	40x1-1/4"	1-1/4"	28.5	86	22.5	102	726,000
8010071875	50x1-1/2"	1-1/2"	32	91	25.5	115	902,800

Female Thread Union

(Soc x Fipt with Metal Insert)

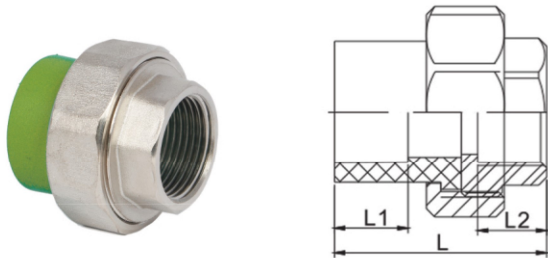

No. SAP	Size (mm)	Inch	L1	L2	L	Price (Rp)
8010072270	20x1/2"	1/2"	16	16	42	113,000
8010072271	25x3/4"	3/4"	18	17	47	211,200
8010072305	25x1"	3/4"x1"	18	18	56.5	237,600
8010072306	32x3/4"	1"x3/4"	20.5	15	56	290,400
8010072355	32x1"	1"	20.5	18	52	303,600

Male Thread Union

(Soc x Mipt with Metal Insert)

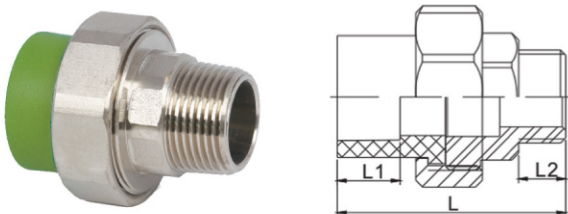

No. SAP	Size (mm)	Inch	L1	L2	L	Price (Rp)
8010072272	20x1/2	1/2"	16.5	72.5	20	184,800
8010072273	25x3/4	3/4"	28.5	86	22.5	290,400
8010072307	25x1	3/4"x1"	32	91	22.5	343,200
8010072308	32x3/4	1"x3/4"				396,000
8010072356	32x1	1"				435,600
8010072850	40x1-1/4	5.92"				650,000
8010072852	50x1-1/2	9.66"				1,056,000
8010072851	63x2	16.53"				1,810,000

Reducing Tee

(Soc x Soc x Soc)

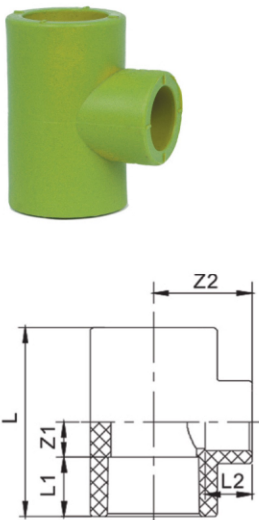

No. SAP	Size (mm)	Inch	Z1	Z2	L1	L2	L	Price (Rp)
8010071360	25x20	3/4"x1/2"	11.5	29.5	18	16	59	8,200
8010071361	32x20	1"x1/2"	12	33.5	20	18	64	13,500
8010071362	32x25	1"x3/4"	14	35	20	18	68	15,500
8010071363	40x20	1-1/4"x1/2"	12	37.5	22.5	16	69	27,000
8010071364	40x25	1-1/4"x3/4"	14.5	40.5	22.5	18	74	30,000
8010071365	40x32	1-1/4"x1"	17.5	42	22.5	20	80	32,500
8010071366	50x20	1-1/2"x1/2"	11.3	42.2	25.5	16	73.5	43,500
8010071367	50x25	1-1/2"x3/4"	13.5	44	25.5	18	78	44,000
8010071368	50x32	1-1/2"x1"	17.5	47.3	25.5	20	86	46,000
8010071369	50x40	1-1/2"x1-1/4"	21.5	49.3	22.5	22.5	94	47,500
8010071370	63x25	2"x3/4"	13.2	42.5	29.5	18	85.6	61,000
8010071371	63x32	2"x1"	16.5	55.5	29.5	20	92	65,000
8010071372	63x40	2"x1-1/4"	20.5	54	29.5	22.5	100	72,500
8010071373	63x50	2"x1-1/2"	25.8	56.8	29.5	25.5	110.5	85,000
8010072304	75x32	2-1/2"x1"	17	62	31.5	20	97	100,000
8010071374	75x40	2-1/2"x1-1/4"	21	59.5	31.5	22.5	105	113,000
8010071375	75x50	2-1/2"x1-1/2"	25.5	62.5	31.5	25.5	114	115,000
8010071376	75x63	2-1/2"x2"	32	67.2	31.5	29.5	127	183,000
8010071352	90x40	3"x1-1/4"	21.3	74	37.5	22.5	117.5	178,000
8010071353	90x50	3"x1-1/2"	26	71.5	37.5	25.5	127	247,500
8010071354	90x63	3"x2"	32.3	75	37.5	29.5	139.5	283,000
8010071355	90x75	3"x2-1/2"	37.5	77.5	37.5	31.5	150	528,000
8010071356	110x50	4"x1-1/2"	27.8	79.5	42	25.5	139.5	429,500
8010071357	110x63	4"x2"	33.8	84	42	29.5	151.5	475,000
8010071358	110x75	4"x2-1/2"	39	87.5	42	31.5	162	545,000
8010071359	110x90	4"x3"	46	91.5	42	37.5	176	645,000

Female Thread Adapter I (Soc x Fipt with Metal Insert)

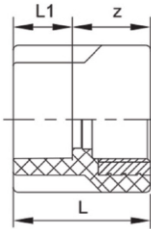

No. SAP	Size (mm)	Inch	Z	L1	L	Price (Rp)
8010071387	20x1/2"	1/2"	26.5	16	42.5	51,000
8010072347	20x3/4"	1/2"x3/4"	26	16	42	80,700
8010071388	25x1/2"	3/4"x1/2"	26.5	18	44.5	52,000
8010071389	25x3/4"	3/4"	27	18	45	72,000
8010072348	32x1/2"	1"x1/2"	31	20	51	72,000
8010071731	32x3/4"	1"x3/4"	27.5	20	47.5	72,000

Female Thread Adapter II (Soc x Fipt with Metal Insert)

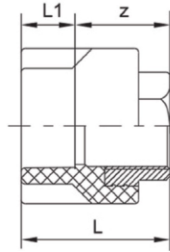

No. SAP	Size (mm)	Inch	Z	L1	L	Price (Rp)
8010072480	20x1/2"	1/2"	34	16	50	145,200
8010072481	20x3/4"	1/2"x3/4"	38.5	16	54.5	290,400
8010072482	25x3/4"	3/4"	39.5	18	57.5	303,600
8010071390	32x1"	1"	38	20	58	245,000
8010072349	40x1"	1-1/4"x1"	37	22	59	462,000
8010071391	40x1-1/4"	1-1/4"	43	22.5	65.5	369,000
8010070614	50x1-1/4"	1-1/2"x1-1/4"	41.5	25.5	67	554,400
8010071392	50x1-1/2"	1-1/2"	52.5	25.5	68	436,000
8010071393	63x2"	2"	46.5	29.5	76	640,000

Male Thread Adapter I (Soc x Mipt with Metal Insert)

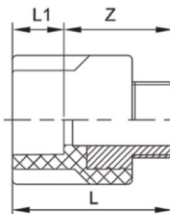

No. SAP	Size (mm)	Inch	Z	L1	L	Price (Rp)
8010071491	20x1/2"	1/2"	38	16	54	68,000
8010072350	20x3/4"	1/2"x3/4"	38	16	54	116,600
8010071492	25x1/2"	3/4"x1/2"	38	18	56	70,000
8010071493	25x3/4"	3/4"	38.5	18	56.5	95,000
8010071494	32x1/2"	1"x1/2"	45	20	65	75,000
8010071732	32x3/4"	1"x3/4"	51.5	20	71.5	97,000

Male Thread Adapter II (Soc x Mipt with Metal Insert)

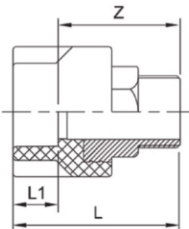

No. SAP	Size (mm)	Inch	Z	L1	L	Price (Rp)
8010071616	32x1"	1"	57	20	77	240,000
8010072351	40x1"	1-1/4"x1"	56	22	78	269,200
8010071495	40x1-1/4"	1-1/4"	64	22.5	86.5	530,000
8010070745	50x 1-1/4"	1-1/2"x1-1/4"	62.5	25.5	88	667,900
8010071496	50x 1-1/2"	1-1/2"	63.5	25.5	89	620,000
8010071497	63x2"	2"	71.5	29.5	101	800,000

Female Thread Elbow I (Soc x Fipt with Metal Insert)

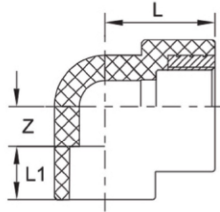

No. SAP	Size (mm)	Inch	Z	L	L1	Price _(Rp)
8010071733	20x1/2"	1/2"	11.5	37.5	16	55,000
8010072354	20x3/4"	1/2"x3/4"	13.1	38.5	16	80,700
8010071394	25x1/2"	3/4"x1/2"	12	40.5	18	49,000
8010071395	25x3/4"	3/4"	13	41	18	79,000
8010072485	32x1/2"	1"x1/2"	15	42	20	55,000
8010071734	32x3/4"	1"x3/4"	18	42	20	70,000

Female Thread Elbow II (Soc x Fipt with Metal Insert)

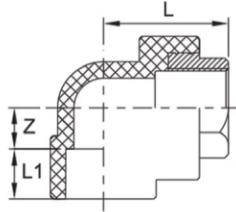

No. SAP	Size (mm)	Inch	Z	L	L1	Price _(Rp)
8010070552	20x1/2"	1/2"	13	44	16	106,400
8010071396	32x1"	1"	16.5	54.5	20	200,000
8010071288	40x1-1/4"	1-1/4"	28.5	65	22.5	480,400
8010071230	50x1-1/2"	1-1/2"	32	70	25.5	460,000

Male Thread Elbow I (Soc x Mipt with Metal Insert)

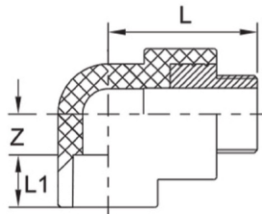

No. SAP	Size (mm)	Inch	Z	L	L1	Price _(Rp)
8010071397	20x1/2"	1/2"	11.5	49	16	71,000
8010072352	20x3/4"	1/2"x3/4"	13.1	50	16	117,600
8010071398	25x1/2"	3/4"x1/2"	12	52	18	76,000
8010071399	25x3/4"	3/4"	17	52.5	18	123,500
8010072483	32x1/2"	1"x1/2"	15	56	20	88,700
8010071735	32x3/4"	1"x3/4"	18	56	20	116,100

Male Thread Elbow II (Soc x Mipt with Metal Insert)

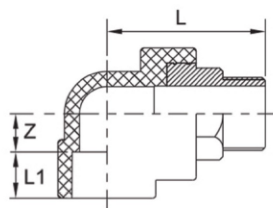
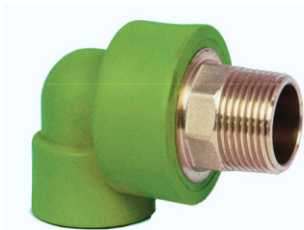

No. SAP	Size (mm)	Inch	Z	L	L1	Price _(Rp)
8010071400	32x1"	1"	21	73.5	20	250,000
8010071286	40x1-1/4"	1-1/4"	28.5	86	22.5	729,300
8010071874	63x2"	2"	33.5	107	29.5	1,100,500

Bending Pipe



No. SAP	Size (mm)	Inch	Price _(Rp)
8010072494	dn20	0.135	16,000
8010072495	dn25	0.219	25,000
8010072496	dn32	0.386	45,000

Flange (Steel Tray)

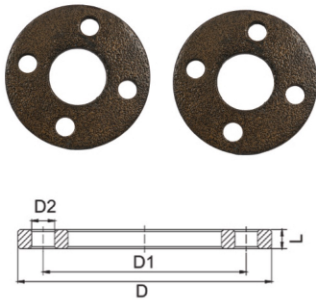

No. SAP	Size (mm)	Inch	D	D1	D2	Price _(Rp)
8010070234	40	1-1/4"	140	100	18	325,000
8010070235	50	1-1/2"	150	110	18	350,000
8010070236	63	2"	160	125	18	415,000
8010070237	75	2-1/2"	185	145	18	575,000
8010070238	90	3"	200	160	18	730,000
8010070232	110	4"	220	180	18	800,000
8010070233	160	6"	285	240	22	1,200,000

Welding Machine



No. SAP	Size (mm)	Model	Price _(Rp)
8010070922	20~63	1000w	3,050,000
8010070923	75~110	1600w	5,900,000
8010070924	160	2500w	10,800,000

Rubber Basket



No. SAP	Size (mm)	Size(inch)	Price _(Rp)
8010070749	40	1-1/4"	7,000
8010070750	50	1-1/2"	13,200
8010070751	63	2"	14,000
8010070752	75	2-1/2"	20,000
8010070753	90	3"	25,000
8010070747	110	4"	27,000
8010070748	160	6"	50,000

Pipe Cutter



No. SAP	Size (mm)	Price _(Rp)
8010070966	16-32	405,000

LESSO

Ahlinya Pipa Plastik

PT. LESSO TECHNOLOGY INDONESIA

China Lesso Group (Stock Code: 2128.HK)

Alamat : Kawasan Industri JIPS Blok D, Jl. Semarang-Demak Km 14.7, Batu, Karangtengah, Kabupaten Demak
Jawa Tengah 59561, Indonesia

Telp: 08112588883

E-Mail: idn.consumer@lesso.com

Website: <https://lessoindonesia.co.id>

LESSO

Ahlinya Pipa Plastik

SNI ISO 9001

SNI ISO 14001

SNI ISO 45001



Pipa pvc LESSO standard dan Fittings

Tanpa Timbal

PT. LESSO TECHNOLOGY INDONESIA

China Lesso Group (Stock Code: 2128.HK)

Alamat : Kawasan Industri JIPS Blok D, Jl. Semarang-Demak Km 14.7, Batu, Karangtengah, Kabupaten Demak
Jawa Tengah 59561, Indonesia

Telp: 08112588883

E-Mail: idn.consumer@lesso.com

Website: <https://lessoindonesia.co.id>

LESSO

Ahlinya Pipa Plastik

PIPA PVC LESSO STANDARD UNTUK APLIKASI AIR BERSIH & AIR LIMBAH						
NO.	DN		OD (mm)	Tebal (mm)	AW** (4 M/BATANG)	D*** (4 M/BATANG)
	mm	Inch				
8010012683	16	1/2"	22	1.50	Rp. 24,200	*
8010012684	20	3/4"	26	1.80	Rp. 32,700	*
8010012691	25	1"	32	2.00	Rp. 44,700	*
8010012692	35	1-1/4"	42	2.30	Rp. 66,800	*
8010012693	40	1-1/2"	48	2.30	Rp. 76,700	*
8010012694	50	2"	60	2.30	Rp. 98,000	*
8010012695	65	2-1/2"	76	2.60	Rp. 142,800	*
8010012696	75	3"	89	3.10	Rp. 201,200	*
8010012697	100	4"	114	4.10	Rp. 333,200	*
8010013700	125	5"	140	5.40	Rp. 527,900	*
8010012698	150	6"	165	6.40	Rp. 740,300	*
8010013701	200	8"	216	8.30	Rp. 1,242,000	*
8010013702	250	10"	267	10.30	Rp. 1,920,000	*
8010013703	300	12"	318	12.20	Rp. 2,710,000	*
8020012377	35	1-1/4"	42	1.30	*	Rp. 41,900
8020012378	40	1-1/2"	48	1.30	*	Rp. 47,400
8020012379	50	2"	60	1.30	*	Rp. 60,800
8020012380	65	2-1/2"	76	1.40	*	Rp. 82,100
8020012381	75	3"	89	1.60	*	Rp. 115,000
8020012382	100	4"	114	2.00	*	Rp. 171,300
8020013759	125	5"	140	2.60	*	Rp. 263,600
8020012383	150	6"	165	3.00	*	Rp. 347,600
8020013760	200	8"	216	4.20	*	Rp. 611,100
8020013761	250	10"	267	5.20	*	Rp. 1,006,600
8020013762	300	12"	318	6.20	*	Rp. 1,413,000

Keterangan :

- **AW / VP : Pipa untuk tekanan kerja 10 Kg / cm² | *** D / VU : Pipa untuk aplikasi air limbah.
- DN: Diameter Nominal | OD: Outside Diameter.
- **Harga sudah termasuk PPN 11%.**

JIS PVC-U AW Fittings

Socket (AW)

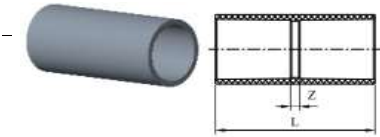

SAP Number	Size (mm)	L	Z	PCS / CTN	HARGA/PCS
8010024550	1/2"	67	7	300	Rp 2.200,00
8010024551	3/4"	77	7	300	Rp 2.600,00
8010024448	1"	87	7	128	Rp 3.800,00
8010024386	1-1/4"	95	4	120	Rp 6.300,00
8010024387	1-1/2"	117	7	78	Rp 9.100,00
8010024812	2"	133	7	96	Rp 14.000,00
8010024327	2-1/2"	145	19	48	Rp 23.300,00
8010024552	3"	155	27	40	Rp 33.500,00
8010024388	4"	200	32	16	Rp 66.100,00
8010024948	6"	286	22	12	Rp 139.100,00

Elbow (AW)

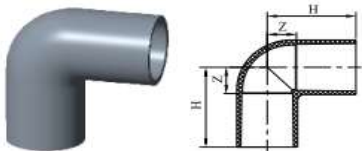

SAP Number	Size (mm)	H	Z	PCS / CTN	HARGA/PCS
8010024350	1/2"	30	13	300	Rp 2.500,00
8010024351	3/4"	50	15	200	Rp 3.200,00
8010024318	1"	58	40	100	Rp 4.700,00
8010024352	1-1/4"	68	22,5	60	Rp 8.100,00
8010024403	1-1/2"	82	27	50	Rp 11.200,00
8010024319	2"	96	33	30	Rp 16.900,00
8010024353	2-1/2"	110	47	36	Rp 26.700,00
8010024354	3"	120	56	24	Rp 44.400,00
8010024355	4"	153	69	10	Rp 82.100,00
8010024404	6"	230	98		Rp 207.500,00

45° Elbow (AW-45L)



SAP Number	Size (mm)	L	Z	PCS / CTN	HARGA/PCS
8010024438	1/2"	37	7	250	Rp 2.400,00
8010024347	3/4"	44	9	200	Rp 3.600,00
8010024348	1"	51	11	100	Rp 5.300,00
8010024349	2"	80	17	60	Rp 19.300,00
8010024873	4"	122	38	10	Rp 80.200,00
8010024874	6"	184	52	3	Rp 228.800,00

Tee (AW)

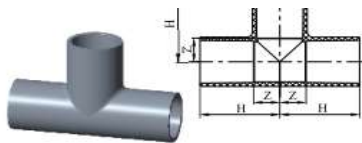

SAP Number	Size (mm)	H	Z	PCS / CTN	HARGA/PCS
8010024356	1/2"	43	13	150	Rp 3.200,00
8010024192	3/4"	50	15	125	Rp 4.300,00
8010024357	1"	58	18	75	Rp 6.900,00
8010024358	1-1/4"	69	23,5	48	Rp 11.300,00
8010024359	1-1/2"	82	27	56	Rp 15.000,00
8010024360	2"	96	33	48	Rp 23.800,00
8010024361	2-1/2"	110	47	24	Rp 38.800,00
8010024362	3"	120	56	15	Rp 54.800,00
8010024363	4"	152	68	7	Rp 109.400,00
8010024982	6"	230	98	2	Rp 274.900,00

Reducing Tee (AW)

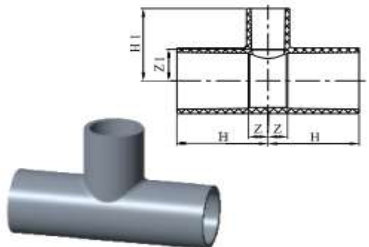

SAP Number	Size (mm)	H	H1	Z	Z1	PCS / CTN	HARGA/PCS
8010024413	3/4" x 1/2"	48	45	13	15	125	Rp 4.300,00
8010024324	1" x 1/2"	53	48	13	18	100	Rp 6.300,00
8010024368	1" x 3/4"	55	53	15	18	100	Rp 6.500,00
8010024369	1-1/4" x 1/2"	59	54	13,5	24	78	Rp 9.100,00
8010024414	1-1/4" x 3/4"	60,5	59	15	24	60	Rp 9.800,00
8010024444	1-1/4" x 1"	64	63	18,5	23	66	Rp 11.000,00
8010024370	1-1/2" x 1/2"	68	57	13	27	48	Rp 12.600,00
8010024371	1-1/2" x 3/4"	70	62	15	27	90	Rp 12.600,00
8010024372	1-1/2" x 1"	73	67	18	27	36	Rp 13.500,00
8010024373	1-1/2" x 1-1/4"	78	73	23	27,5	72	Rp 15.000,00

Reducing Tee (AW)

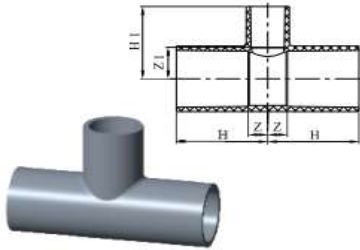

SAP Number	Size (mm)	H	H1	Z	Z1	PCS / CTN	HARGA/PCS	
8010024374	2" x 1 1/2"	76	63	13	33	72	Rp	15.100,00
8010024375	2" x 3/4"	78	68	15	33	60	Rp	15.300,00
8010024376	2" x 1"	81	73	18	33	64	Rp	15.900,00
8010024377	2" x 1-1/4"	86	79	23	33,5	64	Rp	21.700,00
8010024378	2" x 1-1/2"	90	88	27	33	50	Rp	21.800,00
8010024415	3" x 2"	105	110	41	47	18	Rp	42.100,00

Valve Socket (AW)

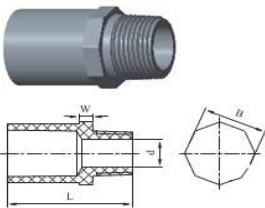

SAP Number	Size (mm)	L	W	d	B	PCS / CTN	HARGA/PCS	
8010024411	1/2"	54	6	13	28,4	450	Rp	1.700,00
8010024659	3/4"	64	8	18	33	300	Rp	2.500,00
8010024412	1"	71	8	23	39,3	180	Rp	3.200,00
8010024660	1-1/4"	80	10	31	49,3	130	Rp	5.700,00
8010024367	1-1/2"	92	10	37	56,2	120	Rp	7.800,00
8010024442	2"	106	12	48	70	132	Rp	11.300,00
8010024810	3"	127	16	75	101		Rp	26.200,00
8010024443	4"	157	18	98	129	24	Rp	46.200,00

Valve Socket (AW)

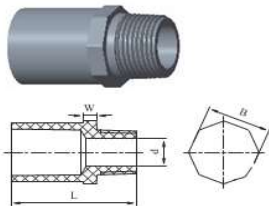

SAP Number	Size (mm)	L	W	d	B	PCS / CTN	HARGA/PCS	
8010024658	3/4"x1/2"	59	6	13	34	390	Rp	2.400,00
8010024561	1/2"x1"	64	8	23	36	300	Rp	2.700,00
8010024549	3/4"x1"	64	8	23	36	300	Rp	2.800,00

Faucet Socket (AW)

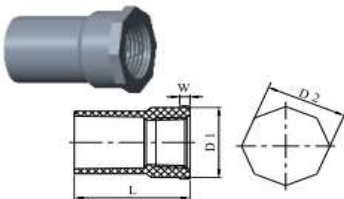

SAP Number	Size (mm)	L	W	D1	D2	PCS / CTN	HARGA/PCS	
8010024365	1/2"	51	5	30	30	400	Rp	2.200,00
8010024323	3/4"	59	4,5	37	39	250	Rp	2.800,00
8010024423	1"	68	6	46	48	125	Rp	4.600,00
8010024366	1-1/4"	72	9	53	53	144	Rp	6.900,00
8010024321	1-1/2"	84	10	58	58	84	Rp	9.100,00
8010024322	2"	99	12	73	73	60	Rp	11.300,00

Faucet Socket (AW)

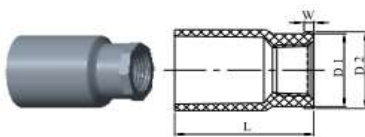

SAP Number	Size (mm)	L	W	D1	D2	PCS / CTN	HARGA/PCS	
8010024876	3/4"x1/2"	55	2	22,5	30	240	Rp	2.600,00
8010024408	1"x1/2"	63	2	22,5	30	100	Rp	3.500,00
8010024548	1/2"x1"	60	6	34,5	46	250	Rp	2.800,00
8010024320	3/4"x1"	64	6	35,5	46	200	Rp	3.700,00

Faucet Socket With Metal Insert (AW)

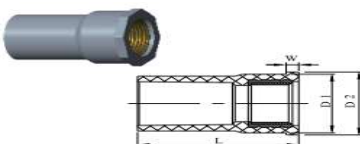

SAP Number	Size (mm)	L	W	D1	D2	PCS / CTN	HARGA/PCS	
8010024389	1/2"	51	4	22,5	30	300	Rp	10.400,00
8010024197	3/4"	59	4,5	28	38,5	240	Rp	16.700,00
8010024198	3/4"x1/2"	57	4	22,5	30	240	Rp	14.800,00

JIS PVC-U AW Fittings

Faucet Tee (AW)

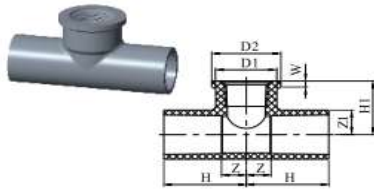

SAP Number	Size (mm)	Z	Z1	W	H	H1	D1	D2	PCS / CTN	HARGA/PCS
8010024364	1/2"	10	15	2	43	32	30	34	192	Rp 4.100,00
8010024421	3/4"	15	17	2,5	50	36	37	42	100	Rp 4.600,00
8010024440	3/4"x1/2"	12	17	2	47	34	30	34	160	Rp 4.300,00
8010024422	1"x1/2"	12	21	2	52	38	30	34	90	Rp 6.000,00

Faucet Tee With Metal Insert (AW)

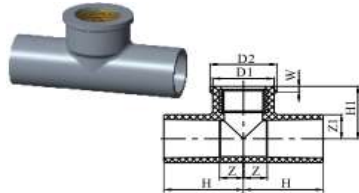

SAP Number	Size (mm)	Z	Z1	W	H	H1	D1	D2	PCS / CTN	HARGA/PCS
8010024563	1/2"	13	14	4	43	30	30	33	300	Rp 16.300,00
8010024424	3/4"	15	18	4	50	36	38.5	42	240	Rp 29.400,00
8010024425	3/4"x1/2"	12	18	4	47	34	30	33	240	Rp 16.900,00

Faucet Elbow (AW)

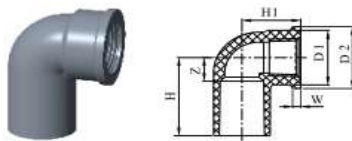

SAP Number	Size (mm)	Z	W	H	H1	D1	D2	PCS / CTN	HARGA/PCS
8010024875	1/2"	13	4	43	30	30	34	300	Rp 2.500,00
8010024806	3/4"	15	4	50	36	37	42	200	Rp 3.700,00
8010024562	1"	21	5	61	43	46	50	120	Rp 5.300,00

Faucet Elbow (AW)



SAP Number	Size (mm)	Z	W	H	H1	D1	D2	PCS / CTN	HARGA/PCS
8010024807	3/4"x1/2"	12	2	47	34	30	34	240	Rp 2.800,00
8010024808	1"x1/2"	12	2	52	38	30	34	160	Rp 4.000,00

Faucet Elbow With Metal Insert (AW)

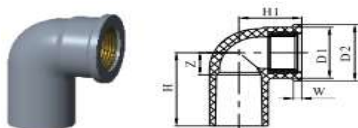

SAP Number	Size (mm)	Z	W	H	H1	D1	D2	PCS / CTN	HARGA/PCS
8010024449	1/2"	13	4	43	30	30	33	240	Rp 10.400,00
8010024418	3/4"	15	4	50	36	37	42	120	Rp 17.600,00
8010024426	3/4"x1/2"	12	4	34	30	30	33	180	Rp 15.100,00

Union Socket (AW)

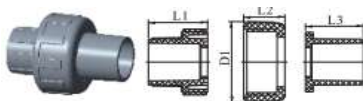

SAP Number	Size (mm)	L1	L2	L3	D1	PCS / CTN	HARGA/PCS
8010024553	1/2"	35	28	34	56	100	Rp 27.800,00
8010024813	3/4"	41	30	39	62	90	Rp 34.000,00
8010024419	1"	46	32	45	69,5	60	Rp 46.600,00
8010024450	1-1/4"	53	36	53	84,4	40	Rp 77.300,00
8010024420	1-1/2"	63	39	63	96,4	30	Rp105.400,00

Union Threaded (AW)



SAP Number	Size (mm)	L1	L2	L3	D1	PCS / CTN	HARGA/PCS
8010024554	1/2"	32,5"	28	31	56	110	Rp 27.800,00
8010024949	3/4"	33	30	30	62	100	Rp 34.000,00
8010024814	1"	38	32	35	70	64	Rp 46.600,00
8010024451	1-1/4"	42	36	37	84	48	Rp 77.300,00
8010024452	1-1/2"	48	39	41	96	40	Rp105.400,00

JIS PVC-U AW Fittings

Plug (AW)

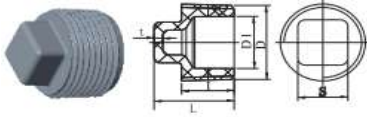

SAP Number	Size (mm)	L	I	D	D1	PCS / CTN	HARGA/PCS
8010024809	1/2"	25,5	16,6	R1/2"	13	1350	Rp 1.400,00
8010024877	3/4"	28	18,7	R3/4"	18		Rp 1.700,00
8010024878	1"	32	21	R1"	23		Rp 1.900,00

Double Nipple (AW)

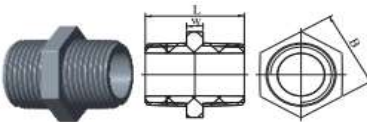

SAP Number	Size (mm)	L	W	B	PCS / CTN	HARGA/PCS
8010024409	1/2"	38	6	24	750	Rp 1.400,00
8010024410	3/4"	42	8	33	450	Rp 1.700,00
8010024441	1"	48	8	40	300	Rp 2.800,00

Cap (AW)

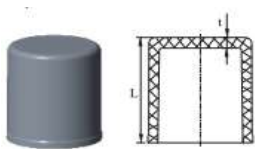

SAP Number	Size (mm)	L	PCS / CTN	HARGA/PCS
8010024405	1/2"	34	510	Rp 1.500,00
8010024406	3/4"	39,2	450	Rp 1.700,00
8010024547	1"	45,5	300	Rp 2.600,00
8010024407	2"	68,8	80	Rp 8.100,00
8010024439	3"	71,65	80	Rp 25.000,00
8010024663	4"	93,55	60	Rp 52.300,00

Flange PVC (AW)

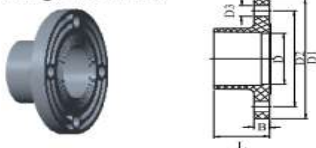

SAP Number	Size (mm)	L	B	D	D1	D2	D3	PCS / CTN	HARGA/PCS
8010024802	2"	70	16	55	155	120	18	24	Rp 33.500,00
8010024803	3"	75	21	85	200	160	18	10	Rp 51.800,00
8010024804	4"	95	22	107	212	180	18	18	Rp 85.500,00
8010024805	6"	144	23	154	285	240	22	5	Rp 195.000,00

Reducing Socket (AW)

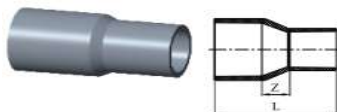

SAP Number	Size (mm)	L	Z	PCS / CTN	HARGA/PCS
8010024193	3/4"x1/2"	71	6	360	Rp 2.700,00
8010024416	1"x1/2"	84	14	160	Rp 2.800,00
8010024194	1"x 3/4"	84	9	200	Rp 3.600,00
8010024379	1-1/4"x1/2"	99	23,5	180	Rp 3.900,00
8010024326	1-1/4"x 3/4"	93	12,5	180	Rp 4.600,00
8010024195	1-1/4"x1"	93	7,5	120	Rp 5.300,00
8010024325	1-1/2"x1/2"	110	25	100	Rp 5.700,00
8010024196	1-1/2"x 3/4"	114	24	100	Rp 6.000,00
8010024380	1-1/2"x1"	114	19	90	Rp 7.300,00
8010024381	1-1/2"x1-1/4"	114	13,5	81	Rp 8.200,00
8010024417	2"x1/2"	136	43	54	Rp 8.500,00
8010024445	2"x 3/4"	136	37	108	Rp 9.100,00
8010024661	2"x1"	136	30	108	Rp 10.000,00
8010024662	2"x1-1/4"	125	16	108	Rp 11.600,00
8010024446	2"x1-1/2"	136	15	108	Rp 12.400,00
8010024382	3"x 2"	165	35	60	Rp 21.600,00
8010024811	4"x1-1/2"	199	57	30	Rp 52.800,00
8010024383	4"x 2"	182	32	30	Rp 57.400,00
8010024384	4"x 3"	190	42	24	Rp 61.300,00
8010024385	6"x 3"	275	79	8	Rp 105.300,00
8010024447	6"x4"	295	79	6	Rp 114.800,00

Large Radius Tee (AW-LT)

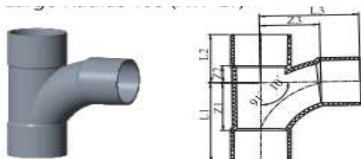

SAP Number	Size (mm)	L1	L2	L3	Z1	Z2	Z3	PCS / CTN	HARGA/PCS
8010025106	4"	341	129	212	128	45	128	6	Rp 177.300,00

Large Radius Tee (AW-LT)

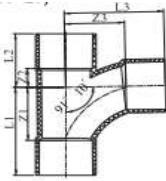

SAP Number	Size (mm)	L1	L2	L3	Z1	Z2	Z3	PCS / CTN	HARGA/PCS
8010025107	4x2"	150	116	153	66	32	90	8	Rp 105.300,00
8010025487	6x4"	260	236	236	128	53	152	5	Rp 336.900,00

Socket (D-DS)

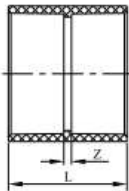

SAP Number	Size (mm)	L	Z	PCS / CTN	HARGA/PCS
8020022639	1-1/4"	39	3	280	Rp 2.300,00
8020022808	1-1/2"	47	3	210	Rp 2.700,00
8020022667	2"	53	3	120	Rp 4.000,00
8020022624	2-1/2"	73	3	120	Rp 6.500,00
8020022668	3"	84	4	60	Rp 10.100,00
8020022669	4"	104	4	36	Rp 17.900,00
8020022670	6"	164	4	12	Rp 43.700,00

Elbow (D-DT)

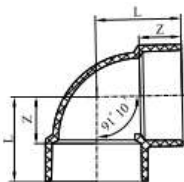

SAP Number	Size (mm)	L	Z	PCS / CTN	HARGA/PCS
8020022746	1-1/4"	44	26	170	Rp 3.400,00
8020022760	1-1/2"	49	27	100	Rp 4.300,00
8020022822	2"	58	33	60	Rp 7.200,00
8020022619	2-1/2"	77	42	150	Rp 11.200,00
8020022650	3"	88	48	35	Rp 16.300,00
8020022806	4"	112	62	18	Rp 32.300,00
8020022807	6"	168	88	5	Rp 94.200,00

45° Elbow (D-45L)

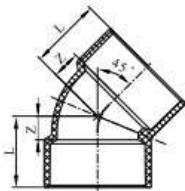

SAP Number	Size (mm)	L	Z	PCS / CTN	HARGA/PCS
8020022805	1-1/4"	30	12	180	Rp 3.200,00
8020022754	1-1/2"	36	14	120	Rp 3.700,00
8020022742	2"	43	18	70	Rp 7.300,00
8020022618	2-1/2"	57	22	35	Rp 9.800,00
8020022755	3"	65	25	40	Rp 15.900,00
8020022756	4"	80	30	21	Rp 26.900,00
8020022757	6"	124	44	5	Rp 99.100,00

Large Radius Elbow (D-DLL)

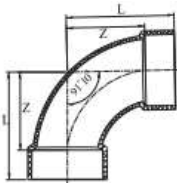

SAP Number	Size (mm)	L	Z	PCS / CTN	HARGA/PCS
8020022759	1-1/4"	63	45	100	Rp 5.300,00
8020022649	2"	91	66	40	Rp 11.400,00
8020022789	3"	140	100	12	Rp 25.500,00
8020022744	4"	178	128		Rp 53.100,00
8020022745	6"	250	170		Rp 159.400,00

Tee (D-DT)

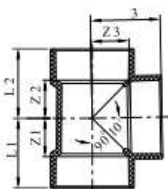

SAP Number	Size (mm)	L1	L2	L3	Z1	Z2	Z3	PCS / CTN	HARGA/PCS
8020022651	1-1/4"	40	40	40	22	22	19.3	108	Rp 4.500,00
8020022652	1-1/2"	49	49	49	27	27	24.3	50	Rp 6.300,00
8020022784	2"	59	59	59	34	34	30.9	40	Rp 9.300,00
8020022628	2-1/2"	77	78	77	42	43	38.9	40	Rp 16.600,00
8020022761	3"	88	89	88	48	49	44.4	35	Rp 24.900,00
8020022653	4"	112	113	112	62	63	57.5	8	Rp 42.500,00
8020022638	6"	169	170	169	89	90	82.7	3	Rp 129.800,00

JIS PVC-U AW Fittings

Tee (D-DT)

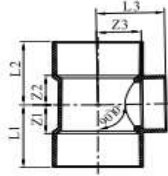

SAP Number	Size (mm)	L1	L2	L3	Z1	Z2	Z3	PCS / CTN	HARGA/PCS
8020022747	3"x1-1/2"	67	68	70	27	28	48	40	Rp 16.600,00
8020022762	3"x2"	74	75	73	34	35	48	36	Rp 19.200,00
8020022763	3"x2-1/2"	82	83	83	42	43	48	30	Rp 21.300,00
8020022823	4"x2"	84	85	87	34	35	62	20	Rp 31.700,00
8020022815	4"x3"	98	99	102	48	49	62	16	Rp 37.200,00
8020022847	6"x4"	142	144	138	62	64	88	5	Rp 101.600,00

Large Radius Tee (D-LT)

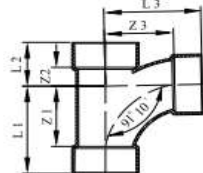

SAP Number	Size (mm)	L1	L2	L3	Z1	Z2	Z3	PCS / CTN	HARGA/PCS
8020022629	1-1/2"	74	45	74	52	23	52	50	Rp 8.000,00
8020022748	2"	91	51	91	66	26	66	64	Rp 15.600,00
8020022846	2-1/2"	125	68	125	90	33	90	28	Rp 24.300,00
8020022785	3"	140	70	140	100	30	100	18	Rp 33.400,00
8020022764	4"	178	95	178	128	45	128	11	Rp 61.300,00
8020022881	6"	250	145	250	170	65	170	2	Rp 198.600,00

Large Radius Tee (D-LT)

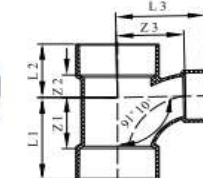

SAP Number	Size (mm)	L1	L2	L3	Z1	Z2	Z3	PCS / CTN	HARGA/PCS
8020022765	1-1/2"x1-1/4"	59	42	60	37	20	42	50	Rp 7.900,00
8020022786	2"x1-1/2"	77	48	79	52	23	57	35	Rp 11.400,00
8020022787	2-1/2"x1-1/2"	87	59	88	52	24	66	50	Rp 15.900,00
8020022766	2-1/2"x2"	101	62	99	66	27	74	36	Rp 19.400,00
8020022749	3"x2"	106	69	104	66	29	79	25	Rp 25.400,00
8020022630	3"x2-1/2"	130	72	130	90	32	95	33	Rp 32.800,00
8020022655	4"x2"	116	82	115	66	32	90	19	Rp 39.200,00
8020022656	4"x3"	150	83	150	100	33	110	8	Rp 53.600,00
8020022750	6"x4"	208	133	202	128	53	152	2	Rp 134.500,00

Y Branch PVC (D)

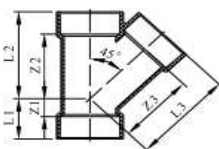

SAP Number	Size (mm)	L1	L2	L3	Z1	Z2	Z3	PCS / CTN	HARGA/PCS
8020022813	2"	43	101	101	18	76	76	56	Rp 14.000,00
8020022821	3"	64	151.5	151,5	24	111.5	111.5	25	Rp 30.000,00
8020022790	4"	80	192.5	192,5	30	142.5	142.5	20	Rp 62.400,00
8020022636	6"	124	284	290	44	204	290	8	Rp 194.400,00
8020022648	1-1/2"	34	80	84	12	58	62	2	Rp 9.000,00

Y Branch PVC (D)

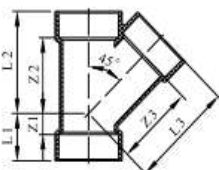

SAP Number	Size (mm)	L1	L2	L3	Z1	Z2	Z3	PCS / CTN	HARGA/PCS
8020022814	1-1/2"x1-1/4"	30	76	79	8	54	57	60	Rp 7.600,00
8020022743	2"x1-1/4"	28	86	87	3	61	69	40	Rp 9.100,00
8020022940	3"x2"	43	126	123	3	86	98	25	Rp 24.500,00
8020022758	4"x2"	42	148	143	8	98	118	20	Rp 38.200,00
8020022791	4"x3"	69	168	172	19	118	132	10	Rp 53.700,00
8020022637	6"x4"	84	245	235	6	165	185	4	Rp 156.400,00

Large Radius Double Tee (D-WLT)

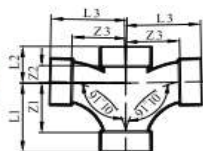

SAP Number	Size (mm)	L1	L2	L3	Z1	Z2	Z3	PCS / CTN	HARGA/PCS
8020022631	2"x2"	90	51	91	66	26	63.73	20	Rp 19.500,00
8020022632	3"x2"	106	69	106	66	29	79	18	Rp 28.900,00
8020022824	4"x4"	178	95	178	128	45	124.04	5	Rp 99.100,00

P-Trap (D)

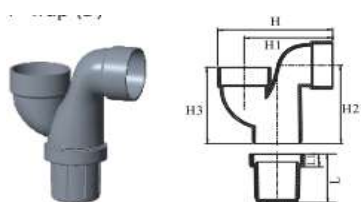

SAP Number	Size (mm)	L	L1	H	H1	H2	H3	PCS / CTN	HARGA/PCS
8020022917	2"	68.5	18.2	145.2	111.7	110	107	20	Rp 16.400,00

Cleanout With Plug (D)

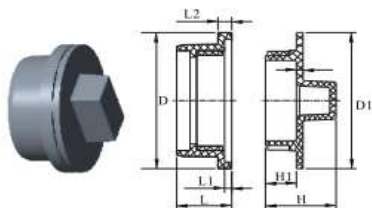

SAP Number	Size (mm)	L	L1	L2	H	H1	D	D1	PCS / CTN	HARGA/PCS
8020022809	2"	26,7	3,5	6,7	34,2	15	73	73	120	Rp 7.100,00
8020022671	3"	39,1	3,5	7,1	42,5	20,5	102,5	102,5	50	Rp 11.200,00
8020022672	4"	49	3,5	8	53	28,5	128	128	30	Rp 28.900,00

Cleanout With Cap (D)

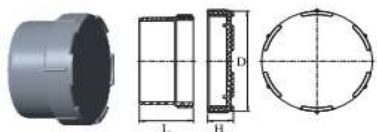

SAP Number	Size (mm)	L	H	D	PCS / CTN	HARGA/PCS
8020022753	4"	64	30,5	135		Rp 29.500,00

Cap (D)

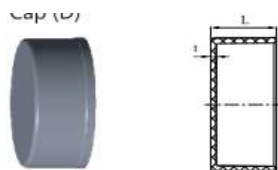

SAP Number	Size (mm)	L	PCS / CTN	HARGA/PCS
8020022620	1-1/4"	20,7	480	Rp 3.900,00
8020022621	1-1/2"	24,7	350	Rp 5.300,00
8020022622	2"	28,1	200	Rp 7.300,00
8020022623	3"	43,6	138	Rp 11.400,00
8020022654	4"	54,5	36	Rp 21.300,00

Increaser (D-IN)

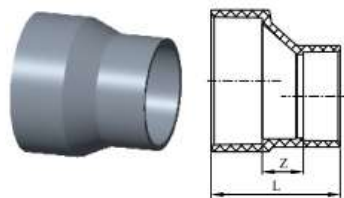

SAP Number	Size (mm)	L	Z	PCS / CTN	HARGA/PCS
8020022657	1-1/2"x 1-1/4"	60	20	150	Rp 3.400,00
8020022658	2"x 1-1/4"	63	20	120	Rp 4.300,00
8020022751	2"x 1-1/2"	67	20	96	Rp 4.500,00
8020022788	2-1/2"x 1-1/2"	77	20	60	Rp 6.900,00
8020022659	2-1/2"x 2"	80	20	60	Rp 7.300,00
8020022660	3"x 1-1/2"	87	25	90	Rp 8.700,00
8020022661	3"x 2"	90	25	33	Rp 9.300,00
8020022752	3"x 2-1/2"	100	25	72	Rp 9.400,00
8020022662	4"x 2"	105	30	48	Rp 15.600,00
8020022663	4"x 2-1/2"	115	30	34	Rp 17.300,00
8020022664	4"x 3"	120	30	42	Rp 18.200,00
8020022665	6"x 3"	161	41	16	Rp 50.300,00
8020022666	6"x 4"	170	40	12	Rp 51.000,00